

This Item can be found on  
[www.OutdoorFurniturePlus.com](http://www.OutdoorFurniturePlus.com)  
[www.CedarwoodFurniture.com](http://www.CedarwoodFurniture.com)

Call **877-595-8543** to order.

This Item can be found on  
[www.OutdoorFurniturePlus.com](http://www.OutdoorFurniturePlus.com)  
[www.CedarwoodFurniture.com](http://www.CedarwoodFurniture.com)

Call **877-595-8543** to order.



Mojave  
Sun IR™

## Infrared Heater Wall Mount

Model#: 60255

**Owner's Manual**

Another lifestyle enhancing product from...



Recommended Primarily  
For Sheltered EXTERNAL Use  
Do NOT expose to rain or moisture

### **READ & SAVE These Instructions**

Carefully read and review before attempting to assemble,  
install, operate or maintain this product. Observe all safety  
instructions and information. **FAILURE TO FOLLOW  
WARNINGS & OPERATIONAL INSTRUCTIONS CONTAINED  
IN THIS MANUAL CAN RESULT IN  
SEVERE PROPERTY DAMAGE AND/OR PERSONAL INJURY.**

\*\*\*\*For Residential Use Only \*\*\*\*

\*\*\* Important Notice \*\*\*

**Do not return to place of purchase!!**

Please contact our Toll Free Hotline:

**(866) WTL-SUPP**

for customer service & warranty issues



**SAVE THESE INSTRUCTIONS !!**

Web: [www.wtliving.com](http://www.wtliving.com)  
Email: [cservice@welltraveled.net](mailto:cservice@welltraveled.net)



Well Traveled Living  
Amelia Island, FL 32034

This Item can be found on  
www.OutdoorFurniturePlus.com  
www.CedarwoodFurniture.com

Call **877-595-8543** to order.

**\*\*\* Important Notice \*\*\***

**Do not return to place of purchase!!**





Please contact our Toll Free Hotline:  
**(866) 985-7877**  
for customer service & warranty issues



## Safety Guidelines

Read this manual carefully for guidance on the assembly and use of this product.

<p><b>▲ DANGER</b> Indicates a potentially hazardous situation which, if not avoided, WILL result in serious injury or death.</p>	<p><b>▲ WARNING</b> Indicates a potentially hazardous situation, if not avoided, COULD result in serious injury or death.</p>
<p><b>▲ CAUTION</b> Indicates a potentially hazardous situation which, if not avoided, MAY cause moderate injury or damage to the equipment.</p>	<p><b>NOTICE:</b> Indicated important information that if not followed, may cause damage to the equipment.</p>

- ▲ DANGER**
-  **Risk of Fire.** There is always a risk of fire when working with a heater. Keep heater away from flammable liquids and materials.
  -  **Risk of Fire.** If falls over this unit might start a fire. Follow instructions above and also for further prevention keep this unit at least 3 feet (.9m) away from everything.
  -  **Hot or Burn Hazard.** This unit may be extremely hot while in use. Use extreme care when handling especially around the head of the unit.
  -  **Electrical Hazard.** Disconnect from electrical outlet before working on the unit to avoid chance of electrical shock.
  -  **Electric Shock.** Do not use near water. Do not use if cord has been damaged.

- ▲ CAUTION**
- Improper treatment of the heater can damage it and also shorten its life span.
  - To prevent electrical shock, ensure electrical plug is properly inserted into the electrical outlet.

This Item can be found on  
www.OutdoorFurniturePlus.com  
www.CedarwoodFurniture.com

Call **877-595-8543** to order.

**\*\*\* Important Notice \*\*\***

**Do not return to place of purchase!!**

Please contact our Toll Free Hotline:  
**(866) 985-7877**  
for customer service & warranty issues

**Recommended Primarily For  
Sheltered EXTERNAL use  
Do NOT expose to  
rain or moisture**



## Product Components & Parts List

***This appliance MUST be grounded.***

- \* When using outdoors, we recommend using a certified GFI (Ground Fault Interrupt) outlet to protect against electrical shock.
- \* Ensure that the heater mounting bracket is SECURELY fastened to the wall, patio overhang or house eave.
- \* Route electrical cable AWAY from main body of heater which gets very hot.
- \* Do NOT cover or obstruct the main body of the heater during use.
- \* All installations must be in accordance with I.E.E. safety regulations or equivalent. If you are unsure, consult an electrical service professional.
- \* Avoid the use of extension cord with this appliance.
- \* Do not place any objects such as furniture, papers, clothing or curtains closer than 3 ft to the front and the sides of the heater.



NOTE: your IR heater main body, electrical components & bracket are fully factory assembled. Do NOT attempt to service or disassemble without proper instructions.

### PARTS LIST

- 1 - IR head unit w/Protective powder coated steel body  
- Pre-installed wall mount component  
- Preassembled aluminum main heating unit  
w/1500W quartz halogen lamp, swivel bracket  
& 12 ft., 16/3 grounded electrical cord.
- 2 - Wall Mounting Bracket
- 3 - Hardware - 4 threaded bolts/screws, phillips pan head, 4 wall anchors, 1 short set screw.

**1**



Head Unit with  
glass plate, pre-  
installed, 16/3  
grounded electrical  
cord, wall mount  
component

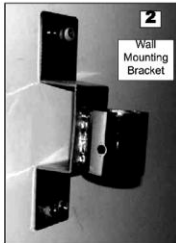

This Item can be found on  
[www.OutdoorFurniturePlus.com](http://www.OutdoorFurniturePlus.com)  
[www.CedarwoodFurniture.com](http://www.CedarwoodFurniture.com)

Call **877-595-8543** to order.

**\*\*\* Important Notice \*\*\***

**Do not return to place of purchase!!**

Please contact our Toll Free Hotline:

**(866) 985-7877**

for customer service & warranty issues



## Important Instructions

1. Read all instructions before using this heater.
2. This heater will get very hot while in use. To avoid burning, do not let bare skin touch hot surface. If provided, use handles when moving this heater. Keep flammable materials, such as furniture, pillows, bedding, papers, clothing, and curtains at least 3 feet (0.9m) from the heater.
3. **DO NOT LEAVE** heater unattended. Extreme caution is necessary when any heater is used by, or near, children or disabled persons, and whenever the heater is left operating and unattended.
4. Always unplug heater when not in use.
5. Do not operate any heater with a damaged cord or plug, if the heater malfunctions, or has been dropped or damaged in any manner. Return heater to authorized service facility for repairs.
6. Can be used indoors or outdoors, operate at least 3 feet (0.9m) from people or objects.
7. Never operate heater near water or where it can be knocked over.
8. Do not run cord under carpeting. Do not cover cord with throw rugs, runners, or similar coverings. Arrange cord away from traffic area and where it will not be tripped over.
9. To disconnect heater, remove plug from electrical outlet.
10. Connect to properly grounded outlets only.
11. Do not insert or allow foreign objects to enter ventilation or exhaust opening; doing so may cause an electrical shock or fire, or may damage the heater.
12. To Prevent a possible fire, do not block air intakes or exhaust in any manner. Do not use on soft surfaces, like a bed, where openings may become blocked.
13. A heater has hot and sparking parts inside. Do not use it in area where gasoline, paint, or flammable liquids are used or stored.
14. Use this heater only as described in this manual. Any other use not recommended by the manufacturer may cause fire, electrical shock, or injury to persons.
15. Avoid the use of an extension cord because the extension cord may overheat and cause a risk of fire. However, if you have to use an extension cord, use either a 12 or 14 gauge wire which is rated not less than 1900 watts. The recommended length for a 14 gauge is 0-50 feet, but if need be long use a 12 gauge no longer than 100 feet.
16. **SAVE THESE INSTRUCTIONS** for future reference.
17. Please keep each side of the head unit at least 11.8 inch from the objects. [Please see the below illustration.]

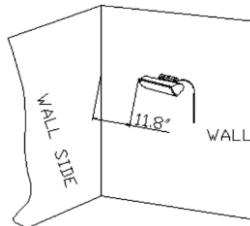

**\*\*\* Important Notice \*\*\***

**Do not return to place of purchase!!**

Please contact our Toll Free Hotline:  
**(866) 985-7877**

for customer service & warranty issues

**Assembly  
& Installation**



**Step 1**

Be sure to read and familiarize yourself with the overall assembly and installation instructions in this manual before beginning. It may be helpful to have someone assist you with the installation. **This unit is primarily designed for outdoor applications.**

**Tools Required.** #2 or #3 Phillips Screwdriver (or standard slotted screwdriver), adjustable wrench, pencil, 5/16" drill and a ladder.

**Step 2**

Find a suitable location to mount the heater unit, **be sure to comply with ALL minimum required distances and clearance specifications. See illustration below, fig. 3.**

\* Do not place any objects such as furniture, papers, clothing or curtains closer than 3 ft to the front and sides of the heater.

- Position mounting bracket flush against the wall where you want to position the IR unit. Make sure the bracket is level and mark the centers of the holes with a pencil. Note the proper upright orientation of the bracket, see fig. 1.

- Drill 4 pilot holes approx. 1 5/8" deep. For mounting on stucco walls and/or locations where there is not a wood stud, be sure to use appropriate wall anchors to properly secure mounting bracket to wall.

- Attached wall bracket using the 4 screws included (and wall anchors if applicable). Apply all 4 screws loosely at first, check that the bracket is level and then tighten securely.

**Step 3**

\* Insert wall mount assembly from head unit into wall mount bracket. See fig. 2.

- Note orientation of bracket and head unit.

\* Align and apply small set screw to bottom of wall bracket and thru the wall mount of the head unit to lock head unit into place. Tighten securely.

**\*\*\* IMPORTANT NOTE: be sure to route and keep the electrical cord AWAY from the main body of the heater unit. \*\*\***

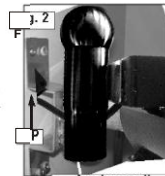
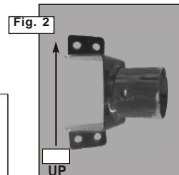
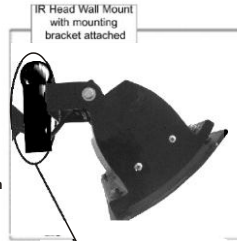

Apply small set screw to lock position of head unit.

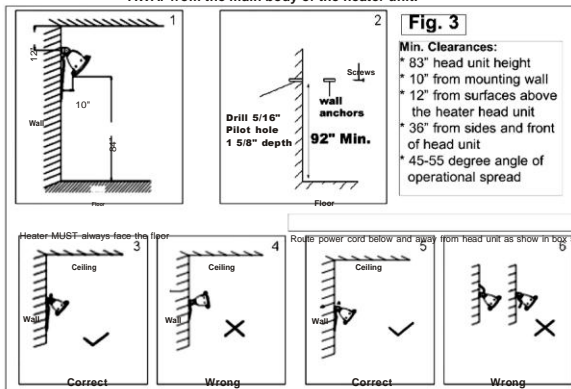

The moving bracket angle may not be more than 45 degrees

**\*\*\* Important Notice \*\*\***

**Do not return to place of purchase!!**

Please contact our Toll Free Hotline:  
**(866) 985-7877**  
 for customer service & warranty issues

**Operating  
 Instructions**



**This appliance MUST be grounded.**

- \* When using outdoors, we recommend using a certified GF (Ground Fault Interrupt) outlet to protect against electrical shock.
- \* Ensure that the heater mounting bracket is SECURELY fastened to the wall, patio overhang or house eave.
- \* Route electrical cable AWAY from main body of heater which gets very hot.
- \* Do NOT cover or obstruct the main body of the heater during use.
- \* All installations must be in accordance with I.E.E. safety regulations or equivalent. If you are unsure, consult an electrical service professional.
- \* Avoid the use of extension cord with this appliance. If one is used, it MUST be at least a 14/3 wire, grounded cord, 50ft max. length.



**\* Do not place any objects such as furniture, papers, clothing or curtains closer than 3 ft to the front and the side of the heater.**

NOTE: your IR Heater main body, electrical components & bracket are fully factory assembled. Do NOT attempt to service or disassemble without proper instructions.

*For optimal performance and safety concerns, we HIGHLY RECOMMEND that the Infrared Heater Head be operated at a min. of 84" ht. with a 45-55 degree angle of operational spread.*

**To Adjust The IR Head Unit:**

Swivel head unit up or down to desired position. The head unit must be at a 45-55 degree angle for optimal operation and output. There should only be a moderate amount of tension to maintain the swivel bracket. If it becomes too loose, tighten hex nuts and bolts at swivel points on head unit bracket. The adjust angle of Head Unit is less than 45 degree.

**Note: Be sure electrical cord is grounded and positioned away from head unit.**

**Step 1**

Before plug your Infrared Heating System, adjust the head unit angle as desired. Do NOT touch the head unit during operation or for 30 minutes AFTER unplug.  
 The head units GETS VERY HOT!

Refer to coverage area in Fig. 7 for best positioning location and heat spread/coverage.

**Step 2**

The infrared electric heating system comes equipped with a heavy duty, 16/3 gauge wire and grounded plug. This appliance must be used with an outlet that has been installed and grounded in accordance with all local codes and ordinances. Makes sure that the heater is connected to an outlet having the same configuration as the plug shown in Fig. 8. Do NOT use an adapter with this product. Check with a licensed electrician if the grounding instructions are not understood completely or if the wall outlet does not match the plug.

**Grounding instructions**

The instruction manual of grounded heaters shall include the following or equivalent wording: (In the case of a heater rated for a nominal 120 volts.) This heater is for use on 120 volts. The cord has a plug as shown at Fig. 65.1 An adapter as shown at C is available for connecting three-blade grounding-type plugs to two-slot receptacles. The green grounding lug extending from the adapter must be connected to a permanent ground such as a properly grounded outlet box. The adapter should not be used if a three-slot grounded receptacle is available.

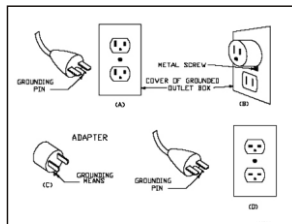
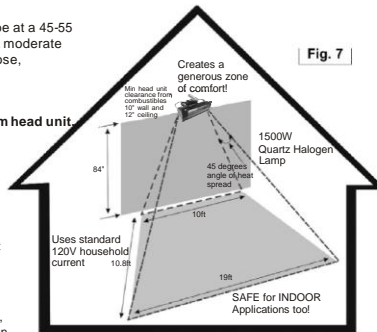

**Step 3**

**Always UNPLUG unit when not in use!**

Your infrared electric heating system is ready to enjoy. Plug the appliance in and begin enjoying the warmth!



This Item can be found on  
www.OutdoorFurniturePlus.com  
www.CedarwoodFurniture.com

Call 877-595-8543 to order.

**\*\*\* Important Notice \*\*\***

**Do not return to place of purchase!**  
Please contact our Toll Free Hotline:  
**(866) 985-7877**  
for customer service & warranty issues

**Maintenance &  
Storage**



**Specifications**

Model:	60255
Voltage:	<b>110-120 volts</b>
Amps:	13.0 amps
Wattage:	1500 watts
Lamp Type:	Quartz Halogen
Min. Operational Height:	84" (7 ft.)
Weight:	6.6 lbs.
Head Unit Dimensions:	18.72" X 9.85" X 6.7"



**Storage Always UNPLUG unit when not in use!**

\* The IR Head unit can be left outside during the season as long as it is mounted under a covered, protected location.  
- During expected moderate weather conditions, we recommend wrapping the head unit with a poly bag and tape or a bungee cord. For extreme weather conditions, it is recommended that you remove the unit from the wall bracket and store in a safe, dry indoor location.

\* When not in use for extended periods of time, the IR Head Unit can be easily removed from the wall mounting bracket for storage indoors. Refer to step 3, page 5 of this manual.  
- **The halogen lamp is fragile, be careful not to hit or jar the head unit.**  
- Store in a dry location placing the head unit on a soft cushioned surface.  
- Make sure the electrical cord is properly coiled and out of the way.

**Maintenance**

Your infrared heating system is virtually maintenance free! A few minutes to wipe down exposed surfaces is all it takes.

\* **Head Unit & Aluminum Shield** Use any non-abrasive cleaner and soft cloth to wipe off debris and dirt from the exposed surfaces of the aluminum shield and outer body of the heat unit and glass plate. NEVER spray any liquids or cleaners into the housing area where the halogen lamp is located. **Do not try to disassemble or clean the inner cavity where the halogen lamp is located.**

Note: For any maintenance on the head unit, please call the toll free customer service hotline.

\* For halogen lamp replacement instructions, refer to information on page 8 of this manual.



**\*\*\* Important Notice \*\*\***

**Do not return to place of purchase!!**

Please contact our Toll Free Hotline:  
**(866) 985-7877**

for customer service & warranty issues

## Halogen Lamp Replacement

Contact toll free customer service hotline to order approved replacement lamps and parts.

**NOTE:** do NOT touch the new halogen lamp with your bare fingers. Oils from your hand could reduce the life of the lamp by causing a heat spot. Recommend using clean cotton or plastic gloves. A clean paper towel may also work.



**Make sure heater is  
DISCONNECTED  
from electrical outlet  
BEFORE beginning**



**Use ONLY approved,  
original equipment  
replacement quartz  
halogen lamps to insure  
safe, proper and maxi-  
mum output operation of  
your infrared heater!**

### Quartz Halogen Lamp Replacement:

- \* Be sure unit is unplugged from wall outlet!
  - \* Remove 2 screws from each end of the head unit as shown in the figure as step 1 and 2
  - \* Remove 4 bolts from the front glass plate as shown in step 3
  - \* Pull out & remove the left & right, front air vent panels and protective glass plate. (see #3)
    - Note position of end clips on vent panel. They must be aligned as close to end connectors of lamp tube as possible when re-assembled. Pull out and/or pushed into place.
  - \* Gently pull out entire old lamp assembly from the clips at the terminal connection ends. (see #4 & #5). Slide and lift the connection ends out from the friction clips by gently pushing apart the clips. Unscrew wire leads from terminal. Remove entire old lamp assembly.
  - \* Gently re-insert connection ends of the NEW lamp assembly into the friction clips (see #4). Pull apart the clips slightly and gently push the connectors into place. Do not allow the metal clips to touch the actual lamp tube. The clips should be about at the center point of the end connectors.
  - \* Reconnect the wire leads to terminal connectors Re-insert vent panels by gently pushing the end clips into housing body, align clip ends close to lamp end connectors and push into place. Insert the 2 screws in each end of the head unit (#1 and #2)
- Replace front glass plate, for best results, insert the 2 bolts for the top of the glass plate first, then insert the 2 bolts for the bottom of the glass plate Do not tighten until all four bolts are inserted

**Do NOT over tighten a gap between the glass and steel housing in necessary for heat venting**

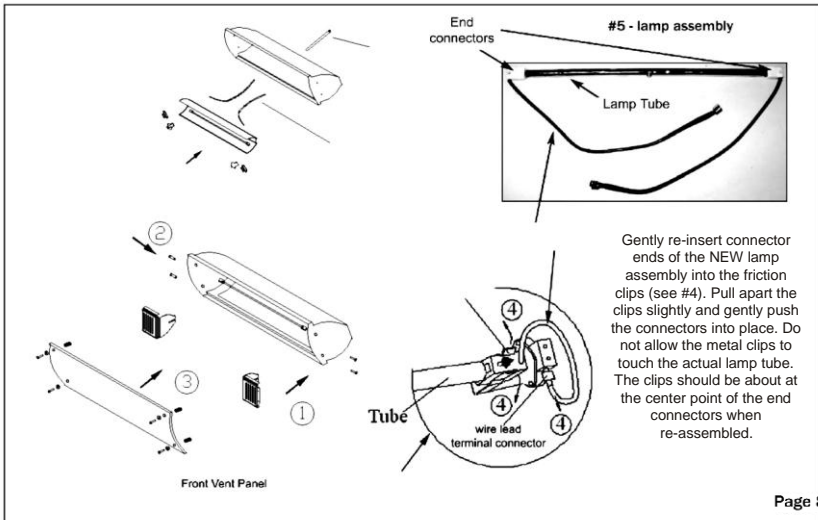

Gently re-insert connector ends of the NEW lamp assembly into the friction clips (see #4). Pull apart the clips slightly and gently push the connectors into place. Do not allow the metal clips to touch the actual lamp tube. The clips should be about at the center point of the end connectors when re-assembled.

This Item can be found on  
[www.OutdoorFurniturePlus.com](http://www.OutdoorFurniturePlus.com)  
[www.CedarwoodFurniture.com](http://www.CedarwoodFurniture.com)

Call **877-595-8543** to order.

## **NOTES**

## Trouble Shooting

Problem	Solution
Unit fails to turn on.	Check electrical plug connection at wall outlet for complete, snug fit. Check GFI circuit, reset breaker if necessary Possibly connected to wall switch that is in off position Damaged halogen lamp, call customer service hotline
Head unit is loose or unsteady Head unit is hard to adjust	Tighten connecting bolts/nuts at swivel bracket Loosen connecting bolts/nuts at swivel bracket
Smoke appears from head unit	Unplug IMMEDIATELY & call customer service hotline
Weak light output from halogen lamp	Life span of lamp has been reached or damaged lamp Call customer service hotline for assistance.

**Distributed By:**  
Well Traveled Living  
716 S 8<sup>th</sup> Street  
Amelia Island, FL 32034  
Toll Free: 866-WTL-SUPP



Web: [www.welltraveled.com](http://www.welltraveled.com)  
Email: [cservice@welltraveled.net](mailto:cservice@welltraveled.net)

### 1 YEAR LIMITED WARRANTY – Customers in the Continental US

All components are warranted for a period of 1 year after date of purchase by the original owner against defects in materials and workmanship under normal use. This warranty does NOT cover normal wear and weathering, assembly and/or maintenance OR use in a commercial application. At Well Traveled Living's sole discretion, products under warranty will be repaired and/or replaced at no charge to the customer. Any returns sent back to Well Traveled Living must be sent via prepaid freight and in the original retail packaging.

For warranty service contact Well Traveled Living at the address, phone numbers or internet site and email listed in this owner's manual. Be sure to have your sales receipt, date of purchase and catalogue/model numbers available when calling. All warranty service will be coordinated by the Well Traveled Living's, Amelia Island, Florida service center.

This warranty is extended only to the original purchaser. Proof of purchase will be required before warranty service is rendered. The sales receipt is the only valid proof of purchase. This warranty only covers failures due to defects in materials or workmanship which occur during normal use. Failures and/or damage which result from accident, negligence, misuse, abuse, neglect, mishandling, alteration or modification, failure to maintain, improper assembly or maintenance, service by unauthorized agency or use of unauthorized components or damage that is attributable to acts of God are NOT covered.

\*\*\*THERE ARE NO EXPRESS WARRANTIES EXCEPT AS LISTED ABOVE\*\*\*

\*\*\*PURCHASER ASSUMES ALL RISKS IN THE ASSEMBLY AND OPERATION OF THIS UNIT\*\*\*

\*\*\*FAILURE TO FOLLOW WARNINGS AND OPERATIONAL INSTRUCTIONS CONTAINED IN THIS MANUAL CAN RESULT IN SEVERE PROPERTY DAMAGE AND/OR PERSONAL INJURY\*\*\*

IN NO EVENT WILL WELL TRAVELED LIVING, OR ITS DIRECTORS, OFFICERS OR AGENTS BE LIABLE TO THE PURCHASER OR ANY THIRD PARTY, WHETHER IN CONTRACT, IN TORT, OR ON ANY OTHER BASIS, FOR ANY INDIRECT, SPECIAL, PUNITIVE, EXEMPLARY, CONSEQUENTIAL, OR INCIDENTAL LOSS, COST, OR DAMAGE ARISING OUT OF OR IN CONNECTION WITH THE SALE, MAINTENANCE, USE, OR INABILITY TO USE THE PRODUCT, EVEN IF WELL TRAVELED LIVING OR ITS DIRECTORS, OFFICERS OR AGENTS HAVE BEEN ADVISED OF THE POSSIBILITY OF SUCH LOSSES, COSTS OR DAMAGES, OR IF SUCH LOSSES, COSTS, OR DAMAGES ARE FORESEEABLE. IN NO EVENT WILL WELL TRAVELED LIVING, OR ITS OFFICERS, DIRECTORS, OR AGENTS BE LIABLE FOR ANY DIRECT LOSSES, COSTS OR DAMAGES THAT EXCEED THE PURCHASE PRICE OF THE PRODUCT.

SOME JURISDICTIONS DO NOT ALLOW THE EXCLUSION OR LIMITATION OF INCIDENTAL OR CONSEQUENTIAL DAMAGES, SO THE ABOVE LIMITATION OR EXCLUSION MAY NOT APPLY TO THE PURCHASER.

This limited warranty gives you specific legal rights and you may also have other rights which vary from jurisdiction to jurisdiction. The provisions of the United Nations Convention on Contracts for the Sales of Goods shall not apply to this limited warranty or the sale of products covered by this limited warranty.

### \*\*\*IMPORTANT NOTICE\*\*\*

-Do NOT return to place of purchase  
For customer service and warranty issues  
contact our Customer Service Center at:  
(866)-985-7877 OR  
Email: [cservice@welltraveled.net](mailto:cservice@welltraveled.net)

Customer Service Hours: Mon. – Fri. 9:00 a.m. – 6:00 p.m. (EST)

Fire Sense® and Well Traveled Living® are registered trademarks of Well Traveled Imports, Inc. All assembly instruction presentation are the property of Well Traveled Imports, Inc. and are protected by U.S. Copyrights and trademarks. All rights reserved.